





Technical Data

| Wire sizes | | Insulating Material | |
|---------------------------|----------------------|--|-----------------|
| Solid min | 0.14 mm ² | Material | PA 6.6 |
| Solid max | 1.5 mm ² | Flammability Class | UL 94 V-0 |
| Stranded (flexible) min | 0.14mm ² | Temperatures | |
| Stranded (flexible) max | 1.5 mm ² | Operating Temperature (without mech. load) | -40 °C - 105 °C |
| Stranded with Ferrule min | 0.25 mm ² | Store Temperature | -40 °C - 105 °C |
| Stranded with Ferrule max | 1.0 mm ² | Wave Soldering Process | |
| Dimensions | | Soldering Temperature, recommended | - |
| Stripped Length | 7.0 mm | Peak Soldering Time, recommended | - |
| Materials | | Reflow Process | |
| Clamp | Brass | Soldering Temperature, recommended | - |
| Screw | Bronze | Peak Soldering Time, recommended | - |
| Contact Spring | Bronze | | |

Colours

| | |
|---|-------------------------------|
|  | GREEN, RAL 6018 |
|  | LIGHT GREY, RAL 7035 |
|  | LIGHT GREEN, similar RAL 6018 |

Colours according to RAL, there may be variations on colour due to production conditions. Special colours on request.

Counterparts (Spacing 7.0 mm)

Pin Strip
STL1550

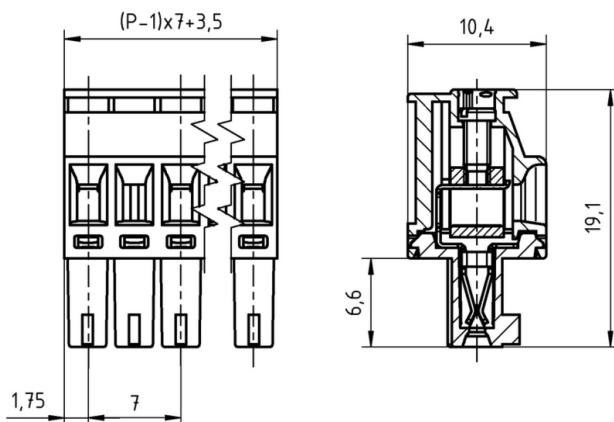

In combination of connectors with different admission data, the lower value is valid.





Order Data (Spacing 7.0 mm)

| Poles | Width (mm) | Article Designation | Article Number | PU |
|-------|------------|---------------------|----------------|-----|
| 2 | 10.50 | AK1700/2-7.0-GREEN | 51700020041 F | 200 |
| 3 | 17.50 | AK1700/3-7.0-GREEN | 51700030041 F | 200 |
| 4 | 24.50 | AK1700/4-7.0-GREEN | 51700040041 E | 100 |
| 5 | 31.50 | AK1700/5-7.0-GREEN | 51700050041 E | 100 |
| 6 | 38.50 | AK1700/6-7.0-GREEN | 51700060041 D | 50 |
| 7 | 45.50 | AK1700/7-7.0-GREEN | 51700070041 D | 50 |
| 8 | 52.50 | AK1700/8-7.0-GREEN | 51700080041 D | 50 |
| 9 | 59.50 | AK1700/9-7.0-GREEN | 51700090041 D | 50 |
| 10 | 66.50 | AK1700/10-7.0-GREEN | 51700100041 D | 50 |

Accessoires

| Figure | Designation | Article Number |
|--|---|-------------------------|
|  | Bridge, 2-pole, insulated, BRI/2-7.0/7.62-L7.5-LIGHT GREY | Order Data: 50000000018 |
|  | Series AK(Z)1710 with pull relief | Order Data: on request |

Ratings

| UseGroup |  | | |  | |
|----------------------|---|---|-----------|---|---------------------------|
| | B | C | D | | |
| Rated Voltage | 300 V | - | 300 V | 300 V | |
| Rated Current | 8 A | - | 8 A | 8 A | |
| Overvoltage Category | | | | III | |
| Rated Wire Size | | | | min | max |
| - solid | AWG 28-16 | - | AWG 28-16 | 0.5 mm ² (6 A) | 1.5 mm ² (8 A) |
| - stranded | AWG 28-16 | - | AWG 28-16 | 0.5 mm ² (6 A) | 1.5 mm ² (8 A) |
| Torque | 0.25 Nm | - | 0.25 Nm | 0.25 Nm | |
| Screw Size | M2 | - | M2 | M2 | |
| Test Voltage | 1.60 kV | - | 1.60 kV | 6.0 kV | |
| Pollution Degree | | | | 3 | |