

STL975/..G-5.0-V-GREEN





A Phoenix Mecano Brand



Technical Data

Wire sizes		Insulating Material	
Solid min	-	Material	PA 6.6
Solid max	-	Flammability Class	UL 94 V-0
Stranded (flexible) min	-	Temperatures	
Stranded (flexible) max	-	Operating Temperature (without mech. load)	-40 °C - 105 °C
Stranded with Ferrule min	-	Store Temperature	-40 °C - 105 °C
Stranded with Ferrule max	-	Wave Soldering Process	
Dimensions		Soldering Temperature, recommended	260 °C
PCB Hole Diameter	1.4 mm	Peak Soldering Time, recommended	3-4 s
Materials		Reflow Process	
Contact Pin	Copper Alloy	Soldering Temperature, recommended	-
		Peak Soldering Time, recommended	-

Colours

-  GREEN, RAL 6018
-  LIGHT GREEN, similar RAL 6018

Colours according to RAL, there may be variations on colour due to production conditions. Special colours on request.

Counterparts (Spacing 5.0 mm)

Terminal Block			
AK950	AK955	AK1100	AK1110

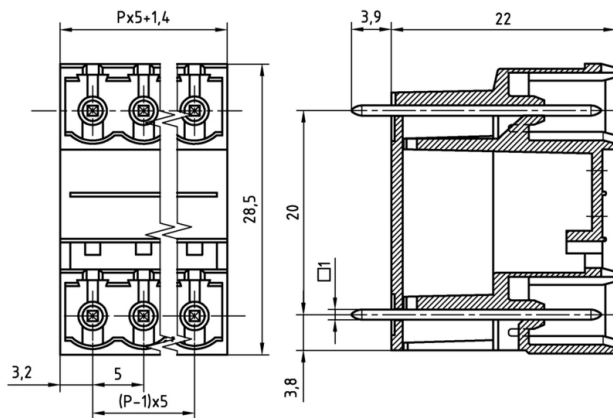

In combination of connectors with different admission data, the lower value is valid.





Order Data (Spacing 5.0 mm)

Poles	Width (mm)	Article Designation	Article Number	PU
2	11.40	STL975/2G-5.0-V-GREEN	50975025101 D	50
3	16.40	STL975/3G-5.0-V-GREEN	50975035101 D	50
4	21.40	STL975/4G-5.0-V-GREEN	50975045101 D	50
5	26.40	STL975/5G-5.0-V-GREEN	50975055101 D	50
6	31.40	STL975/6G-5.0-V-GREEN	50975065101 D	50
7	36.40	STL975/7G-5.0-V-GREEN	50975075101 D	50
8	41.40	STL975/8G-5.0-V-GREEN	50975085101 D	50
9	46.40	STL975/9G-5.0-V-GREEN	50975095101 D	50
10	51.40	STL975/10G-5.0-V-GREEN	50975105101 D	50
11	56.40	STL975/11G-5.0-V-GREEN	50975115101 D	50
12	61.40	STL975/12G-5.0-V-GREEN	50975125101 D	50
13	66.40	STL975/13G-5.0-V-GREEN	50975135101 D	50
14	71.40	STL975/14G-5.0-V-GREEN	50975145101 D	50
15	76.40	STL975/15G-5.0-V-GREEN	50975155101 D	50
16	81.40	STL975/16G-5.0-V-GREEN	50975165101 D	50
17	86.40	STL975/17G-5.0-V-GREEN	50975175101 D	50
18	91.40	STL975/18G-5.0-V-GREEN	50975185101 D	50
19	96.40	STL975/19G-5.0-V-GREEN	50975195101 D	50
20	101.40	STL975/20G-5.0-V-GREEN	50975205101 D	50
21	106.40	STL975/21G-5.0-V-GREEN	50975215101 D	50
22	111.40	STL975/22G-5.0-V-GREEN	50975225101 D	50
23	116.40	STL975/23G-5.0-V-GREEN	50975235101 D	50
24	121.40	STL975/24G-5.0-V-GREEN	50975245101 D	50

Accessoires

Figure	Designation	Article Number
	Coding Star CS2-5.0/5.08-RED	Order Data: 50000000024
	Separating Element SE-STL950-GREEN	Order Data: 50950000002

Ratings

UseGroup	C  US			
	B	C	D	
Rated Voltage	300 V	150 V	300 V	250 V
Rated Current	15 A	15 A	10 A	12 A
Overvoltage Category				III
Test Voltage	1.60 kV	1.30 kV	1.60 kV	4.0 kV
Pollution Degree				3