

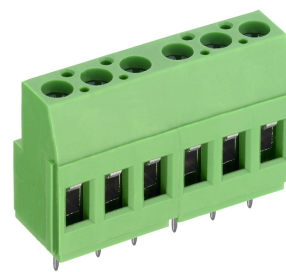





AKZ700/..-5.08-V-GREEN



Technical Data

Wire sizes		Insulating Material	
Solid min	0.2 mm ²	Material	PA 6.6
Solid max	4.0 mm ²	Flammability Class	UL 94 V-0
Stranded (flexible) min	0.2mm ²	Temperatures	
Stranded (flexible) max	2.5 mm ²	Operating Temperature (without mech. load)	-40 °C - 105 °C
Stranded with Ferrule min	0.25 mm ²	Store Temperature	-40 °C - 105 °C
Stranded with Ferrule max	2.5 mm ²	Wave Soldering Process	
Dimensions		Soldering Temperature, recommended	260 °C
Stripped Length	8.0 mm	Peak Soldering Time, recommended	3-4 s
PCB Hole Diameter	1.3 mm	Reflow Process	
Materials		Soldering Temperature, recommended	-
Clamp	Brass	Peak Soldering Time, recommended	-
Screw	Steel		
Solder Tab	Copper Alloy		

Colours

	GREEN, RAL 6018
	GREY, RAL 7016
	PEBBLE GREY, RAL 7032
	BLUE, RAL 5015
	LIGHT GREEN, similar RAL 6018

Colours according to RAL, there may be variations on colour due to production conditions. Special colours on request.

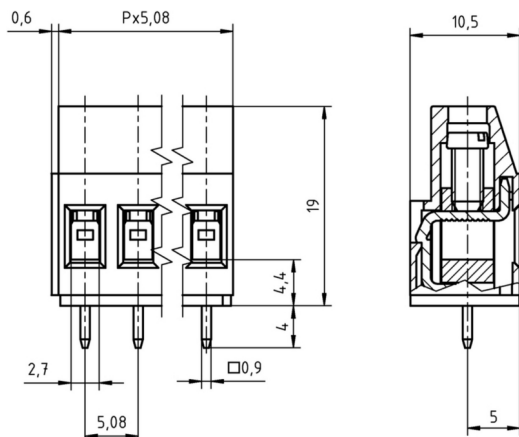

Order Data (Spacing 5.08 mm)

Poles	Width (mm)	Article Designation	Article Number	PU
2	10.76	AKZ700/2-5.08-V-GREEN	50700020213 F	200
3	15.84	AKZ700/3-5.08-V-GREEN	50700030213 F	200
4	20.92	AKZ700/4-5.08-V-GREEN	50700040213 F	200
5	26.00	AKZ700/5-5.08-V-GREEN	50700050213 F	200
6	31.08	AKZ700/6-5.08-V-GREEN	50700060213 E	100
7	36.16	AKZ700/7-5.08-V-GREEN	50700070213 E	100
8	41.24	AKZ700/8-5.08-V-GREEN	50700080213 E	100
9	46.32	AKZ700/9-5.08-V-GREEN	50700090213 E	100
10	51.40	AKZ700/10-5.08-V-GREEN	50700100213 D	50
11	56.48	AKZ700/11-5.08-V-GREEN	50700110213 D	50
12	61.56	AKZ700/12-5.08-V-GREEN	50700120213 D	50

Accessoires

Figure	Designation	Article Number
	Bridge, 2-pole, insulated, BRI/2-5.0/5.08-LIGHT GREY	Order Data: 50000000006
	Bridge, 3-pole, insulated, BRI/3-5.0/5.08-LIGHT GREY	Order Data: 50000000007
	Bridge, 2-pole, BR/2-5.0/5.08-L7.0	Order Data: 50000000008
	Screw Cover SC-AK700-YELLOW	Order Data: 50700000004

Ratings

UseGroup	cRU [®] US			VDE	
	B	C	D		
Rated Voltage	300 V	150 V	300 V	250 V	
Rated Current	20 A	20 A	10 A	24 A	
Rated Wire Size				min	max
- solid	AWG 30-12	AWG 30-12	AWG 30-12	0.5 mm ²	4.0 mm ²
- stranded	AWG 30-12	AWG 30-12	AWG 30-12	0.5 mm ²	2.5 mm ²
Torque	0.45 Nm	0.45 Nm	0.45 Nm	0.50 Nm	
Screw Size	M3	M3	M3	M3	
Test Voltage	1.60 kV	1.30 kV	1.60 kV	2.0 kV	