

AKZ602/..-3.81-V-GREEN





PTR

A Phoenix Mecano Brand

Technical Data

Wire sizes		Insulating Material	
Solid min	0.14 mm ²	Material	PA 6.6
Solid max	1.5 mm ²	Flammability Class	UL 94 V-0
Stranded (flexible) min	0.14mm ²	Temperatures	
Stranded (flexible) max	1.0 mm ²	Operating Temperature (without mech. load)	-40 °C - 105 °C
Stranded with Ferrule min	0.25 mm ²	Store Temperature	-40 °C - 105 °C
Stranded with Ferrule max	0.5 mm ²	Wave Soldering Process	
Dimensions		Soldering Temperature, recommended	260 °C
Stripped Length	5.0 mm	Peak Soldering Time, recommended	3-4 s
PCB Hole Diameter	1.1 mm	Reflow Process	
Materials		Soldering Temperature, recommended	-
Clamp	Brass	Peak Soldering Time, recommended	-
Screw	Bronze		
Solder Tab	Copper Alloy		

Colours

	GREEN, RAL 6018
	LIGHT GREEN, similar RAL 6018



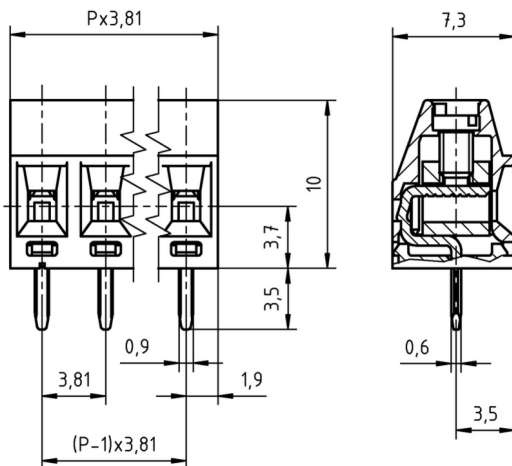

Colours according to RAL, there may be variations on colour due to production conditions. Special colours on request.



Order Data (Spacing 3.81 mm)

Poles	Width (mm)	Article Designation	Article Number	PU
2	7.62	AKZ602/2-3.81-V-GREEN	50602020021 F	200
3	11.43	AKZ602/3-3.81-V-GREEN	50602030021 F	200
4	15.24	AKZ602/4-3.81-V-GREEN	50602040021 F	200
5	19.05	AKZ602/5-3.81-V-GREEN	50602050021 F	200
6	22.86	AKZ602/6-3.81-V-GREEN	50602060021 E	100
7	26.67	AKZ602/7-3.81-V-GREEN	50602070021 E	100
8	30.48	AKZ602/8-3.81-V-GREEN	50602080021 E	100
9	34.29	AKZ602/9-3.81-V-GREEN	50602090021 E	100
10	38.10	AKZ602/10-3.81-V-GREEN	50602100021 D	50
11	41.91	AKZ602/11-3.81-V-GREEN	50602110021 D	50
12	45.72	AKZ602/12-3.81-V-GREEN	50602120021 D	50
13	49.53	AKZ602/13-3.81-V-GREEN	50602130021 D	50
14	53.34	AKZ602/14-3.81-V-GREEN	50602140021 D	50
15	57.15	AKZ602/15-3.81-V-GREEN	50602150021 D	50
16	60.96	AKZ602/16-3.81-V-GREEN	50602160021 D	50

Accessoires

Figure	Designation	Article Number
	Bridge, 2-pole, insulated, BR1/2-7.0/7.62-L7.5-LIGHT GREY	Order Data: 50000000018
	Bridge, 2-pole, angled, BR/2-3.5/3.81-H-L4.7	Order Data: 50000000019
	Bridge, 2-pole, BR/2-3.5/3.81-L4.7	Order Data: 50000000013
	Bridge, 3-pole, BR/3-3.5/3.81-L4.7	Order Data: 50000000014

Ratings

UseGroup	C ^{RU} US			VDE	
	B	C	D		
Rated Voltage	300 V	-	-	130 V	
Rated Current	10 A	-	-	13.5 A	
Rated Wire Size				min	max
- solid	AWG 30-16	-	-	0.5 mm ²	1.0 mm ²
- stranded	AWG 30-16	-	-	0.5 mm ²	1.0 mm ²
Torque	0.25 Nm	-	-	0.20 Nm	
Screw Size	M2	-	-	M2	
Test Voltage	1.60 kV	-	-	1.25 kV	