



AK300/..-5.0-GREY



Technical Data

Wire sizes		Insulating Material	
Solid min	0.14 mm ²	Material	PA 6.6
Solid max	2.5 mm ²	Flammability Class	UL 94 V-0
Stranded (flexible) min	0.14mm ²	Temperatures	
Stranded (flexible) max	1.5 mm ²	Operating Temperature (without mech. load)	-40 °C - 105 °C
Stranded with Ferrule min	0.25 mm ²	Store Temperature	-40 °C - 105 °C
Stranded with Ferrule max	1.5 mm ²	Wave Soldering Process	
Dimensions		Soldering Temperature, recommended	260 °C
Stripped Length	7.0 mm	Peak Soldering Time, recommended	3-4 s
PCB Hole Diameter	1.3 mm	Reflow Process	
Materials		Soldering Temperature, recommended	-
Clamp	Brass	Peak Soldering Time, recommended	-
Screw	Steel		
Solder Tab	Copper Alloy		

Colours

	GREY, RAL 7016
	GREEN, RAL 6018
	BLUE, RAL 5015

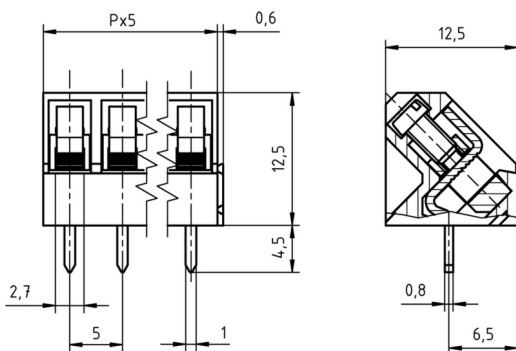

Colours according to RAL, there may be variations on colour due to production conditions. Special colours on request.



Order Data (Spacing 5.0 mm)

Poles	Width (mm)	Article Designation	Article Number	PU
2	10.60	AK300/2-5.0-GREY	50300020041 F	200
3	15.60	AK300/3-5.0-GREY	50300030041 F	200
4	20.60	AK300/4-5.0-GREY	50300040041 F	200
5	25.60	AK300/5-5.0-GREY	50300050041 F	200
6	30.60	AK300/6-5.0-GREY	50300060041 F	200
7	35.60	AK300/7-5.0-GREY	50300070041 E	100
8	40.60	AK300/8-5.0-GREY	50300080041 E	100
9	45.60	AK300/9-5.0-GREY	50300090041 E	100
10	50.60	AK300/10-5.0-GREY	50300100041 D	50
11	55.60	AK300/11-5.0-GREY	50300110041 D	50
12	60.60	AK300/12-5.0-GREY	50300120041 D	50

Accessoires

Figure	Designation	Article Number
	Bridge, 2-pole, insulated, BRI/2-5.0/5.08-LIGHT GREY	Order Data: 50000000006
	Bridge, 3-pole, insulated, BRI/3-5.0/5.08-LIGHT GREY	Order Data: 50000000007
	Bridge, 2-pole, BR/2-5.0/5.08-L7.0	Order Data: 50000000008

Ratings

UseGroup	C ^{RU} US			VDE	
	B	C	D		
Rated Voltage	300 V	-	300 V	250 V	
Rated Current	15 A	-	10 A	24 A	
Rated Wire Size				min	max
- solid	AWG 22-12	-	AWG 22-12	0.5 mm ²	2.5 mm ²
- stranded	AWG 22-12	-	AWG 22-12	0.5 mm ²	1.5 mm ²
Torque	0.40 Nm	-	0.40 Nm	0.40 Nm	
Screw Size	M2.6	-	M2.6	M2.6	
Test Voltage	1.60 kV	-	1.60 kV	2.0 kV	