

AK3001/..WD-10.0-PEBBLE GREY

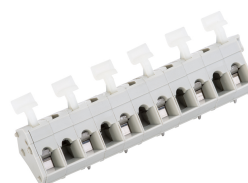







- 2 to n poles

Technical Data

Wire sizes		Insulating Material	
Solid min	0.08 mm ²	Material	PA 6.6
Solid max	2.5 mm ²	Flammability Class	UL 94 V-0
Stranded (flexible) min	0.14mm ²	Temperatures	
Stranded (flexible) max	2.5 mm ²	Operating Temperature (without mech. load)	-40 °C - 105 °C
Stranded with Ferrule min	0.14 mm ²	Store Temperature	-40 °C - 105 °C
Stranded with Ferrule max	1.5 mm ²	Wave Soldering Process	
Dimensions		Soldering Temperature, recommended	260 °C
Stripped Length	6.0 mm	Peak Soldering Time, recommended	3-4 s
PCB Hole Diameter	1.1 mm	Reflow Process	
Materials		Soldering Temperature, recommended	-
Solder Tab	Copper Alloy	Peak Soldering Time, recommended	-
Tension Spring	Stainless Steel		

Colours

	PEBBLE GREY, RAL 7032
	GREY, RAL 7016
	LIGHT GREEN, similar RAL 6018
	GREEN, RAL 6018
	RED, RAL 3003
	ORANGE, RAL 2011
	BLUE, RAL 5015

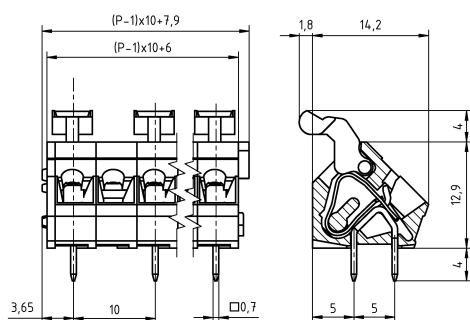

Colours according to RAL, there may be variations on colour due to production conditions. Special colours on request.



Order Data (Spacing 10.0 mm)

Poles	Width (mm)	Article Designation	Article Number	PU
2	17.90	AK3001/2WD-10.0-PEBBLE GREY	53001020071 E	100
3	27.90	AK3001/3WD-10.0-PEBBLE GREY	53001030071 E	100
4	37.90	AK3001/4WD-10.0-PEBBLE GREY	53001040071 E	100
5	47.90	AK3001/5WD-10.0-PEBBLE GREY	53001050071 E	100
6	57.90	AK3001/6WD-10.0-PEBBLE GREY	53001060071 D	50
7	67.90	AK3001/7WD-10.0-PEBBLE GREY	53001070071 D	50
8	77.90	AK3001/8WD-10.0-PEBBLE GREY	53001080071 D	50
9	87.90	AK3001/9WD-10.0-PEBBLE GREY	53001090071 D	50
10	97.90	AK3001/10WD-10.0-PEBBLE GREY	53001100071 D	50
11	107.90	AK3001/11WD-10.0-PEBBLE GREY	53001110071 D	50
12	117.90	AK3001/12WD-10.0-PEBBLE GREY	53001120071 D	50
13	127.90	AK3001/13WD-10.0-PEBBLE GREY	53001130071 D	50
14	137.90	AK3001/14WD-10.0-PEBBLE GREY	53001140071 D	50
15	147.90	AK3001/15WD-10.0-PEBBLE GREY	53001150071 D	50
16	157.90	AK3001/16WD-10.0-PEBBLE GREY	53001160071 D	50
17	167.90	AK3001/17WD-10.0-PEBBLE GREY	53001170071 D	50
18	177.90	AK3001/18WD-10.0-PEBBLE GREY	53001180071 D	50
19	187.90	AK3001/19WD-10.0-PEBBLE GREY	53001190071 D	50
20	197.90	AK3001/20WD-10.0-PEBBLE GREY	53001200071 D	50
21	207.90	AK3001/21WD-10.0-PEBBLE GREY	53001210071 D	50
22	217.90	AK3001/22WD-10.0-PEBBLE GREY	53001220071 D	50
23	227.90	AK3001/23WD-10.0-PEBBLE GREY	53001230071 D	50
24	237.90	AK3001/24WD-10.0-PEBBLE GREY	53001240071 D	50

Ratings

UseGroup					
	B	C	D		
Rated Voltage	300 V	300 V	-	1000 V	
Rated Current	15 A	15 A	-	24 A	
Rated Wire Size				min	max
- solid	AWG 28-14	AWG 28-14	-	0.5 mm ²	2.5 mm ²
- stranded	AWG 28-14	AWG 28-14	-	0.5 mm ²	2.5 mm ²
Test Voltage	1.60 kV	1.60 kV	-	3.5 kV	