

AK950/..-5.0-GREEN-HC



Technical Data

Wire sizes		Insulating Material	
Solid min	0.2 mm ²	Material	PA 6.6
Solid max	4.0 mm ²	Flammability Class	UL 94 V-0
Stranded (flexible) min	0.2mm ²	Temperatures	
Stranded (flexible) max	2.5 mm ²	Operating Temperature (without mech. load)	-40 °C - 105 °C
Stranded with Ferrule min	0.25 mm ²	Store Temperature	-40 °C - 105 °C
Stranded with Ferrule max	2.5 mm ²	Wave Soldering Process	
Dimensions		Soldering Temperature, recommended	-
Stripped Length	6.0 mm	Peak Soldering Time, recommended	-
Materials		Reflow Process	
Clamp	Brass	Soldering Temperature, recommended	-
Screw	Steel	Peak Soldering Time, recommended	-
Contact Spring	Copper Alloy		

Colours

	GREEN, RAL 6018
	BLACK, RAL 9011
	PEBBLE GREY, RAL 7032
	LIGHT GREEN, similar RAL 6018

Colours according to RAL, there may be variations on colour due to production conditions. Special colours on request.

Counterparts (Spacing 5.0 mm)

Pin Strip		
STL950	STL950-HC-HT	STL950-G-HC-HT



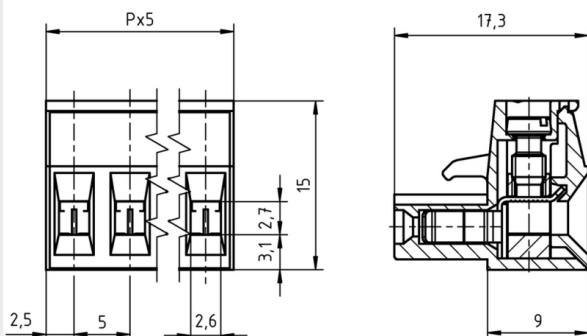

In combination of connectors with different admission data, the lower value is valid.



Order Data (Spacing 5.0 mm)

Poles	Width (mm)	Article Designation	Article Number	PU
2	10.00	AK950/2-5.0-GREEN-HC	50950020009 F	200
3	15.00	AK950/3-5.0-GREEN-HC	50950030009 F	200
4	20.00	AK950/4-5.0-GREEN-HC	50950040009 F	200
5	25.00	AK950/5-5.0-GREEN-HC	50950050009 E	100
6	30.00	AK950/6-5.0-GREEN-HC	50950060009 E	100
7	35.00	AK950/7-5.0-GREEN-HC	50950070009 E	100
8	40.00	AK950/8-5.0-GREEN-HC	50950080009 D	50
9	45.00	AK950/9-5.0-GREEN-HC	50950090009 D	50
10	50.00	AK950/10-5.0-GREEN-HC	50950100009 D	50
11	55.00	AK950/11-5.0-GREEN-HC	50950110009 D	50
12	60.00	AK950/12-5.0-GREEN-HC	50950120009 D	50

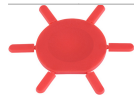
Accessoires

Figure	Designation	Article Number
	Series AK(Z)950 with pull relief	Order Data: on request
	Bridge, 2-pole, insulated, BRI/2-5.0/5.08-LIGHT GREY	Order Data: 50000000006
	Bridge, 3-pole, insulated, BRI/3-5.0/5.08-LIGHT GREY	Order Data: 50000000007
	Coding Star CS1-5.0/5.08-RED	Order Data: 50000000021
	Bridge, 2-pole, BR/2-5.0/5.08-L7.0	Order Data: 50000000008
	Series AK(Z)950 with Separating Element	Order Data: on request

Ratings

UseGroup	cRU [®] US			VDE	
	B	C	D		
Rated Voltage	300 V	150 V	300 V	250 V	
Rated Current	16 A	16 A	10 A	16 A	
Overtoltage Category				III	
Rated Wire Size				min	max
	- solid	AWG 22-12	AWG 22-12	AWG 22-12	0.5 mm ² (5 A) / 2.5 mm ² (16 A)
- stranded	AWG 22-12	AWG 22-12	AWG 22-12	0.5 mm ² (5 A) / 2.5 mm ² (16 A)	
Torque	0.50 Nm	0.50 Nm	0.50 Nm	0.50 Nm	
Screw Size	M3	M3	M3	M3	
Test Voltage	1.60 kV	1.30 kV	1.60 kV	4.0 kV	
Pollution Degree				3	