

# STLZ970/..F-10.16-H-GREEN

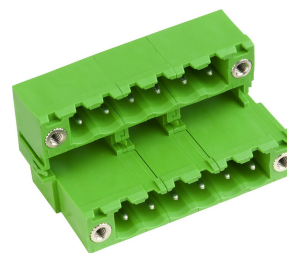



A Phoenix Mecano Brand



## Technical Data

Wire sizes		Insulating Material	
Solid min	-	Material	PBT
Solid max	-	Flammability Class	UL 94 V-0
Stranded (flexible) min	-	<b>Temperatures</b>	
Stranded (flexible) max	-	Operating Temperature (without mech. load)	-40 °C - 105 °C
Stranded with Ferrule min	-	Store Temperature	-40 °C - 105 °C
Stranded with Ferrule max	-	<b>Wave Soldering Process</b>	
<b>Dimensions</b>		Soldering Temperature, recommended	260 °C
PCB Hole Diameter	1.4 mm	Peak Soldering Time, recommended	3-4 s
<b>Materials</b>		<b>Reflow Process</b>	
Thread Insert, Flange	Brass	Soldering Temperature, recommended	-
Contact Pin	Copper Alloy	Peak Soldering Time, recommended	-

## Colours

-  GREEN, RAL 6018
-  LIGHT GREEN, similar RAL 6018

Colours according to RAL, there may be variations on colour due to production conditions. Special colours on request.

## Counterparts (Spacing 10.16 mm)

Terminal Block	
AKZ1200	AKZ950

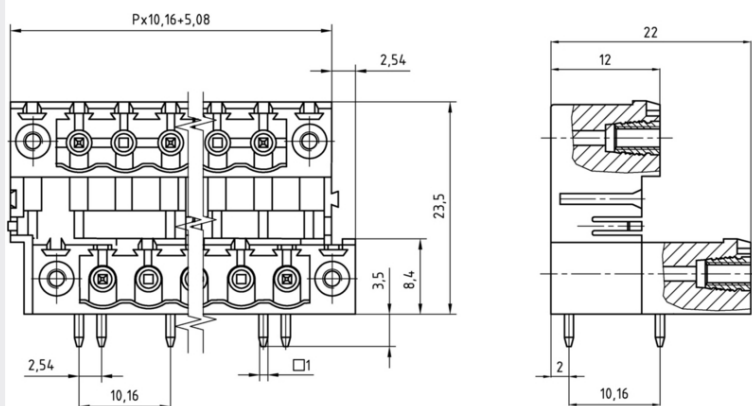

In combination of connectors with different admission data, the lower value is valid.





## Order Data (Spacing 10.16 mm)

Poles	Width (mm)	Article Designation	Article Number	PU
2	27.94	STLZ970/2F-10.16-H-GREEN	50970026061 D	50
3	38.10	STLZ970/3F-10.16-H-GREEN	50970036061 D	50
4	48.26	STLZ970/4F-10.16-H-GREEN	50970046061 D	50
5	58.42	STLZ970/5F-10.16-H-GREEN	50970056061 D	50
6	68.58	STLZ970/6F-10.16-H-GREEN	50970066061 D	50

## Accessoires

Figure	Designation	Article Number
	Coding Star CS2-5.0/5.08-RED	Order Data: 50000000024
	Separating Element SE-STL950-GREEN	Order Data: 50950000002

## Ratings

UseGroup	C  US			
	B	C	D	
Rated Voltage	300 V	150 V	300 V	500 V
Rated Current	15 A	15 A	-	12 A
Overvoltage Category				III
Test Voltage	1.60 kV	1.30 kV	1.60 kV	6.0 kV
Pollution Degree				3