

STLZ1570/..F-3.81-V-GREEN





A Phoenix Mecano Brand



Technical Data

Wire sizes		Insulating Material	
Solid min	-	Material	PBT
Solid max	-	Flammability Class	UL 94 V-0
Stranded (flexible) min	-	Temperatures	
Stranded (flexible) max	-	Operating Temperature (without mech. load)	-40 °C - 105 °C
Stranded with Ferrule min	-	Store Temperature	-40 °C - 105 °C
Stranded with Ferrule max	-	Wave Soldering Process	
Dimensions		Soldering Temperature, recommended	260 °C
PCB Hole Diameter	1.2 mm	Peak Soldering Time, recommended	3-4 s
Materials		Reflow Process	
Thread Insert, Flange	Brass	Soldering Temperature, recommended	-
Contact Pin	Copper Alloy	Peak Soldering Time, recommended	-

Colours

-  GREEN, RAL 6018
-  LIGHT GREEN, similar RAL 6018

Colours according to RAL, there may be variations on colour due to production conditions. Special colours on request.

Counterparts (Spacing 3.81 mm)

Terminal Block				
AKZ1550	AKZ1700	AKZ1710	AKZ4551	AKZ4561

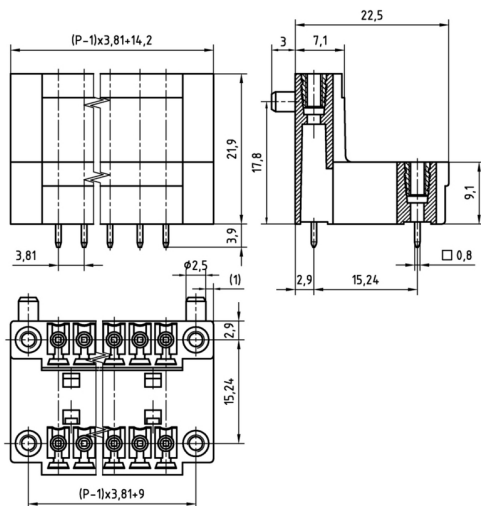

In combination of connectors with different admission data, the lower value is valid.





Order Data (Spacing 3.81 mm)

Poles	Width (mm)	Article Designation	Article Number	PU
2	18.01	STLZ1570/2F-3.81-V-GREEN	51570026121 D	50
3	21.82	STLZ1570/3F-3.81-V-GREEN	51570036121 D	50
4	25.63	STLZ1570/4F-3.81-V-GREEN	51570046121 D	50
5	29.44	STLZ1570/5F-3.81-V-GREEN	51570056121 D	50
6	33.25	STLZ1570/6F-3.81-V-GREEN	51570066121 D	50
7	37.06	STLZ1570/7F-3.81-V-GREEN	51570076121 D	50
8	40.87	STLZ1570/8F-3.81-V-GREEN	51570086121 D	50
9	44.68	STLZ1570/9F-3.81-V-GREEN	51570096121 D	50
10	48.49	STLZ1570/10F-3.81-V-GREEN	51570106121 D	50
11	52.30	STLZ1570/11F-3.81-V-GREEN	51570116121 D	50
12	56.11	STLZ1570/12F-3.81-V-GREEN	51570126121 D	50
13	59.92	STLZ1570/13F-3.81-V-GREEN	51570136121 D	50
14	63.73	STLZ1570/14F-3.81-V-GREEN	51570146121 D	50
15	67.54	STLZ1570/15F-3.81-V-GREEN	51570156121 D	50
16	71.35	STLZ1570/16F-3.81-V-GREEN	51570166121 D	50
17	75.16	STLZ1570/17F-3.81-V-GREEN	51570176121 D	50
18	78.97	STLZ1570/18F-3.81-V-GREEN	51570186121 D	50
19	82.78	STLZ1570/19F-3.81-V-GREEN	51570196121 D	50
20	86.59	STLZ1570/20F-3.81-V-GREEN	51570206121 D	50

Accessoires

Figure	Designation	Article Number
	Coding Star CS1-3.5/3.81-RED	Order Data: 50000000023
	Separating Element SE-STL1550-GREEN	Order Data: 51550000002

Ratings

UseGroup	C  US			
	B	C	D	
Rated Voltage	300 V	-	300 V	160 V
Rated Current	10 A	-	10 A	10 A
Overvoltage Category				III
Test Voltage	1.60 kV	-	1.60 kV	2.5 kV
Pollution Degree				3