

# STLZ1550/..F-3.81-H-GREEN

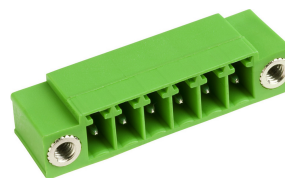





A Phoenix Mecano Brand

## Technical Data

Wire sizes		Insulating Material	
Solid min	-	Material	PA 6.6
Solid max	-	Flammability Class	UL 94 V-0
Stranded (flexible) min	-	<b>Temperatures</b>	
Stranded (flexible) max	-	Operating Temperature (without mech. load)	-40 °C - 105 °C
Stranded with Ferrule min	-	Store Temperature	-40 °C - 105 °C
Stranded with Ferrule max	-	<b>Wave Soldering Process</b>	
<b>Dimensions</b>		Soldering Temperature, recommended	260 °C
PCB Hole Diameter	1.2 mm	Peak Soldering Time, recommended	3-4 s
<b>Materials</b>		<b>Reflow Process</b>	
Thread Insert, Flange	Brass	Soldering Temperature, recommended	-
Contact Pin	Copper Alloy	Peak Soldering Time, recommended	-

## Colours

	GREEN, RAL 6018
	BLACK, RAL 9011
	BASALT GREY, RAL 7012
	LIGHT GREEN, similar RAL 6018

Colours according to RAL, there may be variations on colour due to production conditions. Special colours on request.

## Counterparts (Spacing 3.81 mm)

Terminal Block				
AKZ1550	AKZ1700	AKZ1710	AKZ4551	AKZ4561

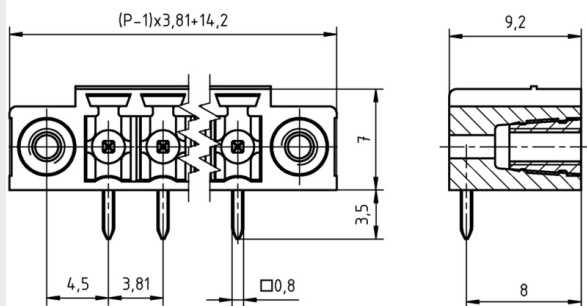

In combination of connectors with different admission data, the lower value is valid.





## Order Data (Spacing 3.81 mm)

Poles	Width (mm)	Article Designation	Article Number	PU
2	18.01	STLZ1550/2F-3.81-H-GREEN	51550026025 E	100
3	21.82	STLZ1550/3F-3.81-H-GREEN	51550036025 E	100
4	25.63	STLZ1550/4F-3.81-H-GREEN	51550046025 E	100
5	29.44	STLZ1550/5F-3.81-H-GREEN	51550056025 D	50
6	33.25	STLZ1550/6F-3.81-H-GREEN	51550066025 D	50
7	37.06	STLZ1550/7F-3.81-H-GREEN	51550076025 D	50
8	40.87	STLZ1550/8F-3.81-H-GREEN	51550086025 D	50
9	44.68	STLZ1550/9F-3.81-H-GREEN	51550096025 D	50
10	48.49	STLZ1550/10F-3.81-H-GREEN	51550106025 D	50
11	52.30	STLZ1550/11F-3.81-H-GREEN	51550116025 D	50
12	56.11	STLZ1550/12F-3.81-H-GREEN	51550126025 D	50
13	59.92	STLZ1550/13F-3.81-H-GREEN	51550136025 D	50
14	63.73	STLZ1550/14F-3.81-H-GREEN	51550146025 D	50
15	67.54	STLZ1550/15F-3.81-H-GREEN	51550156025 D	50
16	71.35	STLZ1550/16F-3.81-H-GREEN	51550166025 D	50
17	75.16	STLZ1550/17F-3.81-H-GREEN	51550176025 D	50
18	78.97	STLZ1550/18F-3.81-H-GREEN	51550186025 D	50
19	82.78	STLZ1550/19F-3.81-H-GREEN	51550196025 D	50
20	86.59	STLZ1550/20F-3.81-H-GREEN	51550206025 D	50

## Accessoires

Figure	Designation	Article Number
	Coding Star CS1-3.5/3.81-RED	Order Data: 50000000023
	Separating Element SE-STL1550-GREEN	Order Data: 51550000002

## Ratings

UseGroup	C  US			
	B	C	D	
Rated Voltage	300 V	-	300 V	160 V
Rated Current	10 A	-	10 A	10 A
Overvoltage Category				III
Test Voltage	1.60 kV	-	1.60 kV	2.5 kV
Pollution Degree				3